

easy ray™ Ze

Swiveling arm stand



easy ray



SWISS  **MADE**

MTS 
Maschinenbau AG

Advantages

of the easy ray Ze

- **Modular**
The integrated system offers optimum modularity. The specification can be adapted according to the customer's needs. Further to several wall mount possibilities, the unit can also be delivered as a self-supporting version with a dedicated fixing frame.
- **Compact**
The swiveling arm technology turns this single station system into a space-saving system with functional design. The easy ray™ Ze is the ideal solution for rooms with limited space.
- **Safe, swift and simple**
The manual operation allows for a very efficient and safe operation of the device. The quick positioning possibilities result in a high patient throughput and an increased number of exams. Thanks to the easy handling, operators will be able to focus their attention on the patients.
- **Cost**
The use of high-quality components helps to minimize costs throughout the entire lifetime of the equipment, thus ensuring a cost optimized operation.
- **Mechanical features**
The easy ray™ Ze is fixed to the floor and wall and carries the rotating transversal arm with the height adjustable Z-shaped arm. Given the very small distance to the floor, it is possible to make X-ray exposures of the knee under load without the need of a footstool. The X-ray system can be completed with a multi-purpose table. The FFD (Film-Focus-Distance) can be adjusted from 1100 to 2000 mm.

Accuracy

in design and production



Cabling concept



Indication of the transversal arm rotation angle



Indication of the format for collimation on the image receptor support



Tube rotation with indexing

Positioning

fast and easy

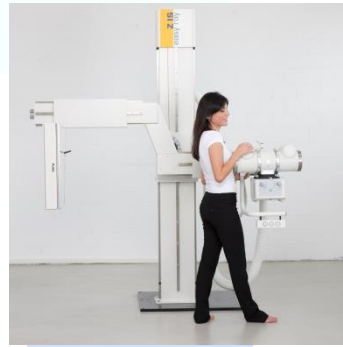
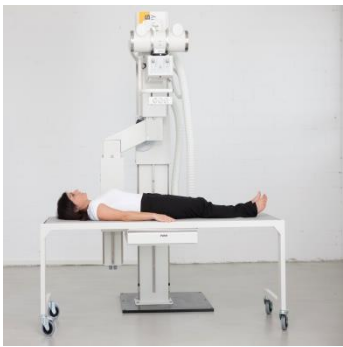

Options

adapted to your requirements

- Versions with tube on left or right side
- Several wall mount lengths starting at 20mm from the wall
- Custom painted system components

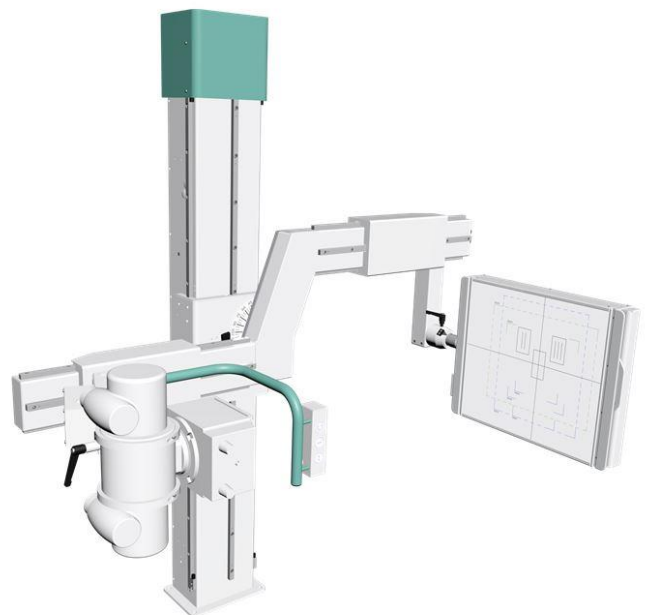

Made-to-measure

Technical specifications



Specifications of the wall column

Height	2175 mm
Ceiling height	2500 mm

Transversal arm

Central beam min. from ground	310 mm
Central beam max. from ground	1620 mm
Swiveling range of the transversal arm	-30° to +135°
Receptor support TE for detector 14" x 17"	Drawer with rotating mechanism, Panel removable
Receptor support TE for detector 17" x 17"	Drawer, Panel removable, firmly installed
Receptor support TE for CR / analogue	with motorized oscillating grid
Anti-scattering grid	with motorized oscillating or static grid, extricable
Inclination of TE device	-45° to +45°
Manual FFD adjustment	
FFD range	1100 to 2000 mm
Tube assembly rotation	-90° / + 180°

Technical data subject to modification

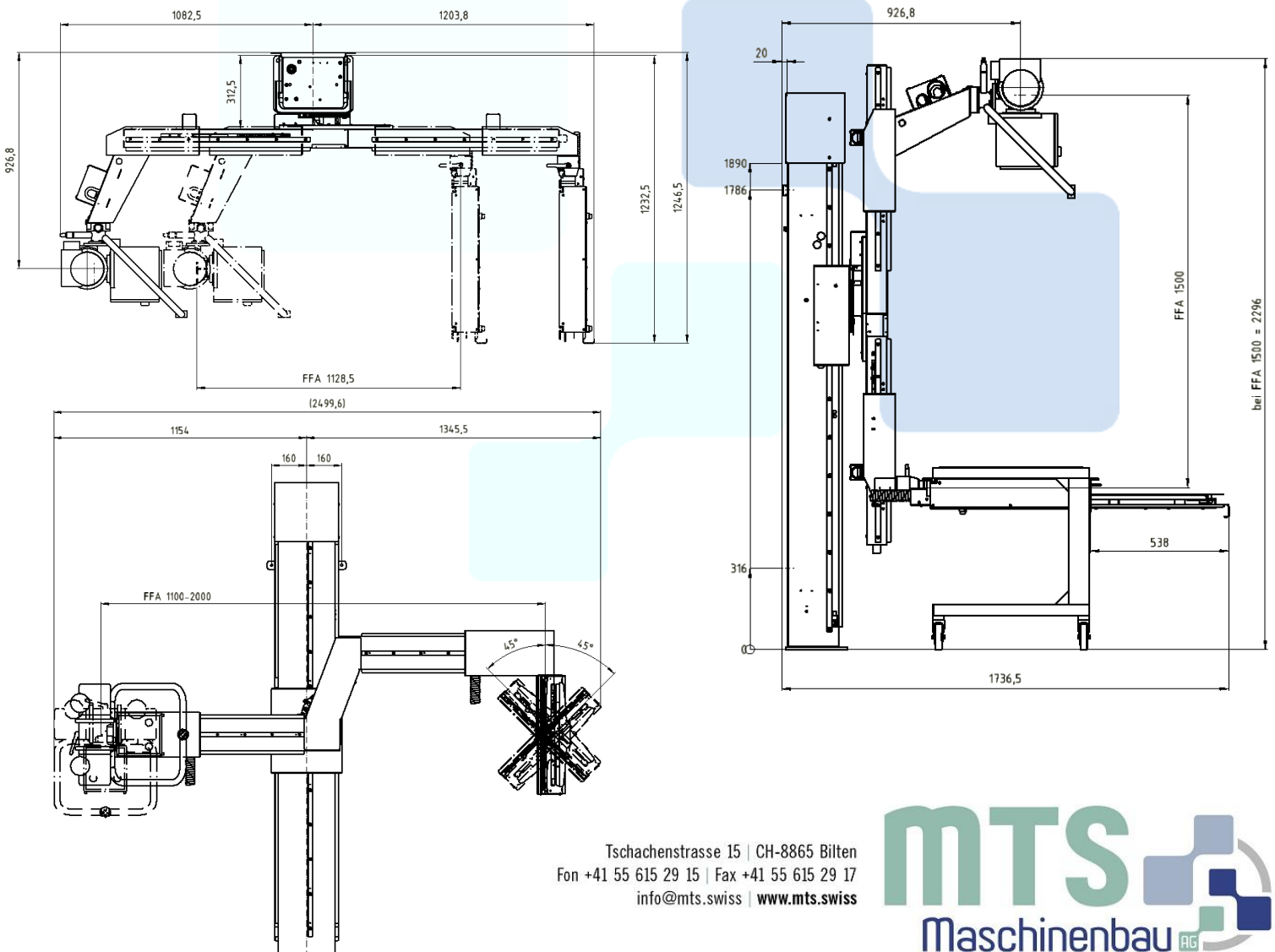

Tschachenstrasse 15 | CH-8865 Bilten
 Fon +41 55 615 29 15 | Fax +41 55 615 29 17
 info@mts.swiss | www.mts.swiss